

structo

WALL
SYSTEMS



POSSIBLE TO USE
DIFFERENT GLASS
TYPES IN DIFFERENT
WINDOWS

DOUBLE GLAZING
FOR BETTER
SOUNDPROOFING

DOUBLELINE – A6

Maximum wall height:	2700 mm
Suitable glasses for both layers with a thickness:	6 - 6,76 mm



+372 666 5017



info@structo.ee



www.structo.ee

DOUBLELINE - A6

TECHNICAL DESCRIPTION



DOUBLELINE-A6 is a double glazed wall system made with aluminum profiles for glasses between 6 - 6,76mm.

The total width of the perimeter profiles is 74mm and the height is 30mm.

The standard surface finish of aluminum profiles is natural (silver) anodizing but it is also possible to order a painted surface according to the RAL colour catalogue.

Possible types of glass are tempered, laminated or tempered-laminated.

The surface of the glass can be bright, very bright, mass-tinted, background-painted or matte.

For better soundproofing is advisable to use different glass types for inner and outer glass layer.

It's possible to use different glass types in different windows e.g. bottom row matte glass and top row bright glass.

A 5mm black circular cross-section EPDM top seal is used as the glass seal.

The structures adjacent to the product must be strong enough to allow profiles to be attached to them.

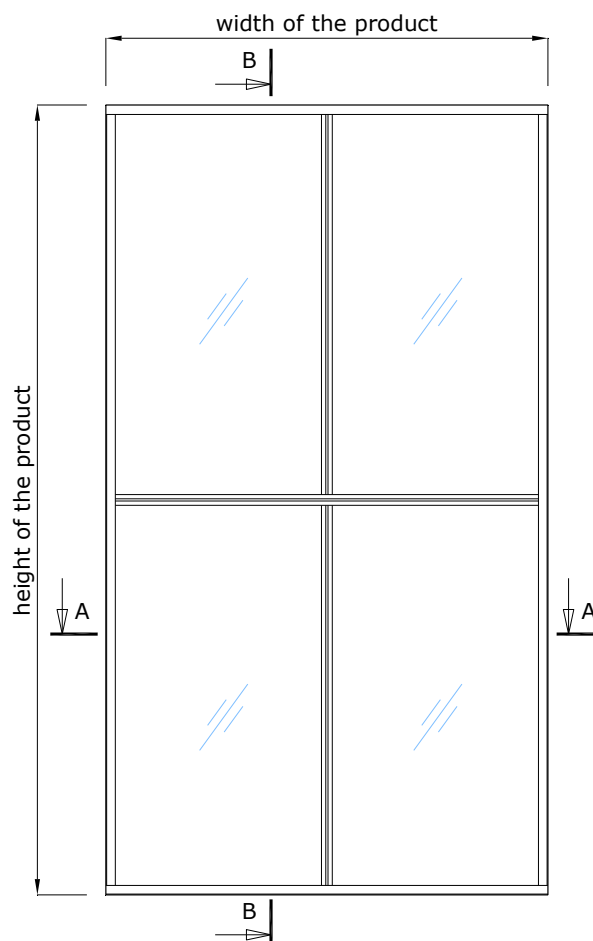

Maximum wall height:	2700 mm
Suitable glasses for both layers with a thickness:	6 - 6,76 mm

DOUBLELINE - A6

STANDARD SOLUTION

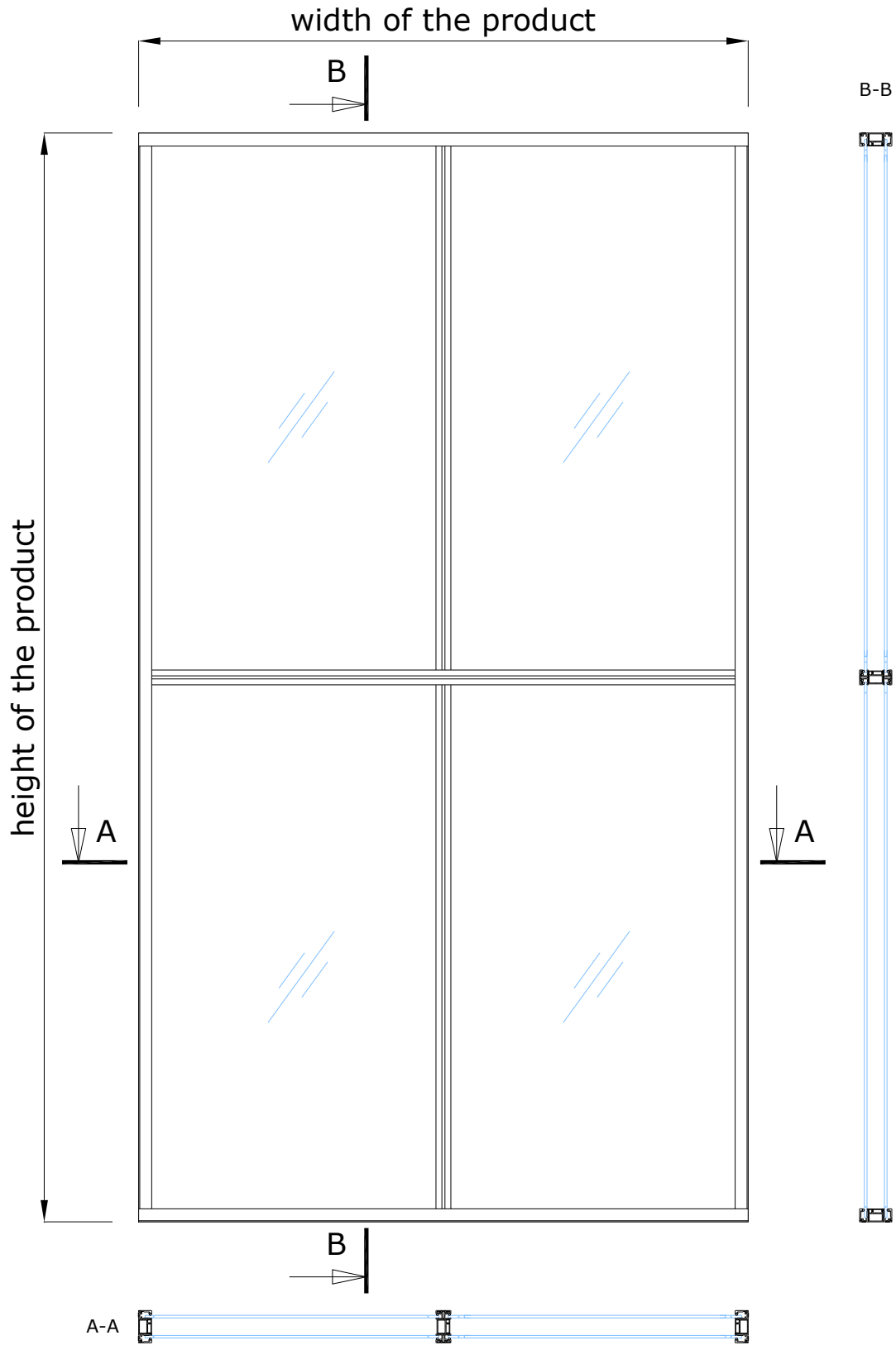

DOUBLELINE - A6

CONNECTION UNITS



CONNECTION WITH CEILING

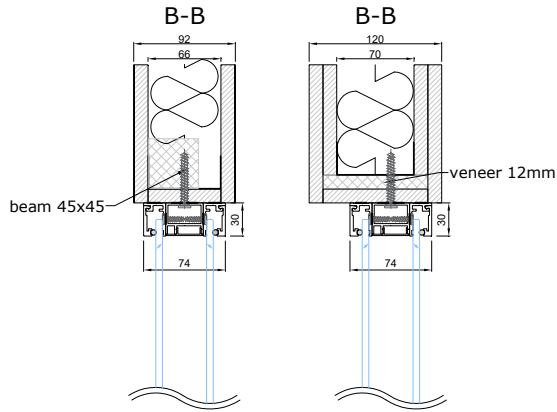

CONNECTION WITH WALL

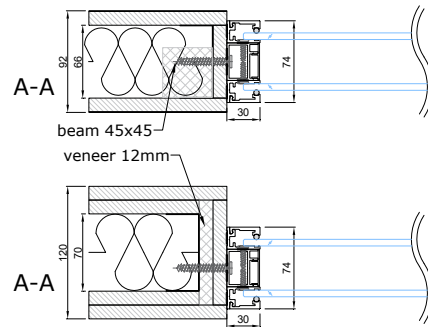

CONNECTION WITH FLOOR

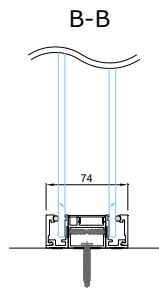

HORIZONTAL AND VERTICAL CONNECTION GLASS-GLOSS

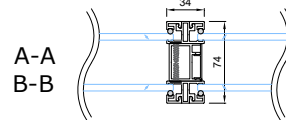

90° CONNECTION UNIT WITH PORTAL PORTA-92A OR ELZONE-92A

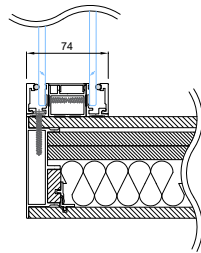

- - seal, EPDM-50Dha_5mm_BLACK
- | - seal, FIX-SEAL/S 3x10mm, black
- - AFTC double-sided tape, 2,5x5mm / 3x7mm / 3x10mm, colourless

CONNECTION WITH PORTA-92A OR ELZONE-92A

